

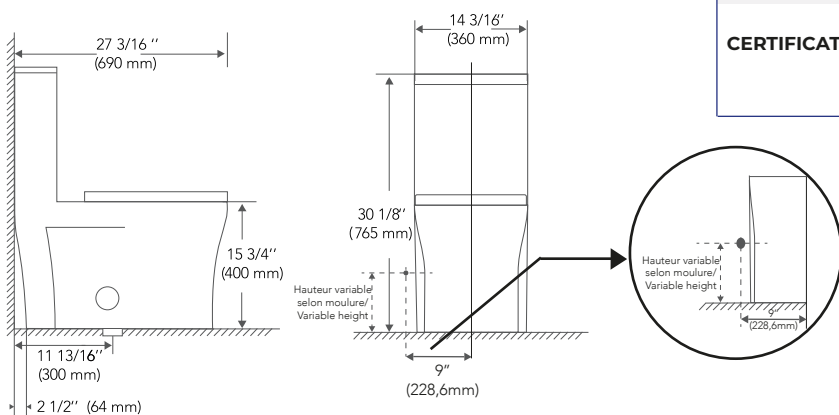

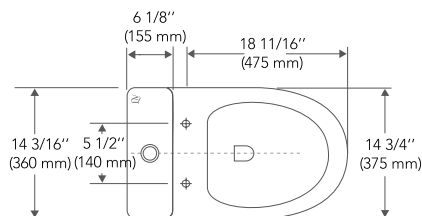



SAINT-LAURENT

Toilette monopièce
One-piece toilet



SPÉCIFICATIONS | SPECIFICATIONS

UTILISATION D'EAU WATER USE	4/6 Lpf, 1.1/1.6 Gpf système de vidange double 4/6 Lpf, 1.1/1.6 Gpf, dual flush
SYSTÈME D'ÉVACUATION FLUSH SYSTEM	Double chasse à action siphonique Siphonic Dual Flush
BOUTON DE LA CHASSE FLUSH BUTTON	Bouton au fini chrome poli placé sur le dessus Polished chrome knob push on top
CAPACITÉ D'ÉVACUATION FLUSH CAPACITY	Map score: 1000 g
TYPE DE SIPHON TRAPWAY TYPE	Drain 2" entièrement vitrifié 2" Fully glazed trapway
DRAIN D'ÉVACUATION ROUGH-IN	S-trap 300mm/12"
MATÉRIEL MATERIAL	Porcelaine Porcelain
COULEUR DISPONIBLE AVAILABLE COLOR	Blanc White
TYPE DE CUVE BOWL TYPE	Allongée Elongated
SIÈGE SEAT	Siège avec fermeture lente et détachable Soft close seat, quick release
DIMENSIONS DE LA BOÎTE BOX DIMENSIONS	29 1/2" x 16" x 31"
POIDS NET NET WEIGHT	97 lbs — 44 kg
POIDS BRUT GROSS WEIGHT	102 lbs — 46 kg
ACCESSOIRES INCLUS INCLUDED ACCESSORIES	Beigne de cire, 2 Boulons de toilette 5/16" et un connecteur flexible tressé 3/8 x 12". Wax donut, 2 Toilet bolts 5/16" and speedway 3/8 x12" braided.
CERTIFICATIONS	     



2024-One World Supply Inc. Tous droits réservés.
2024-One World Supply Inc. All right reserved.

oneworldsupply.ca



Luxury Innovation Valuable
-FIXTURES-